

HOE KIEST U

HOW TO CHOOSE

Een riemschijf

A pulley

Om een riemschijf te kiezen, controleert u het volgende:

To choose a V-pulley, you have to check :

- Het aantal groeven
The number of grooves
- De steekdiameter
The pitch diameter
- De grootte van de bijbehorende Taper-Lock klembus
The size of the taper lock bush that will be fitted on
- De doorsnede van de V-riem
The V-belt section

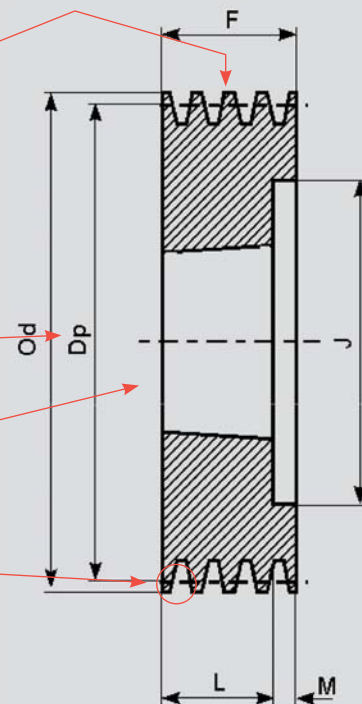

De riemschijf op de foto is bijvoorbeeld een **SPA 106 x 1 TL1610 -4MP**

For example, the pulley on the photo is

Profiel voor een V-riem type SPA
Profile for SPA trapezoidal belt

Steekdiameter van de riemschijf in mm
Pitch diameter of the pulley in mm

1 groef
1 groove

1610 = grootte van de bijbehorende Taper-Lock klembus
1610 = size of the taper lock bush



Al onze riemschijven zijn vervaardigd van gietijzer GG25 en gefosfateerd om ze te beschermen tegen corrosie.
Our trapezoidal pulleys are made of cast iron GG25, phosphated, in order to protect them from rust.

Taper-Lock V-riemschijven met 1 groef 1 groove taper lock V-pulleys

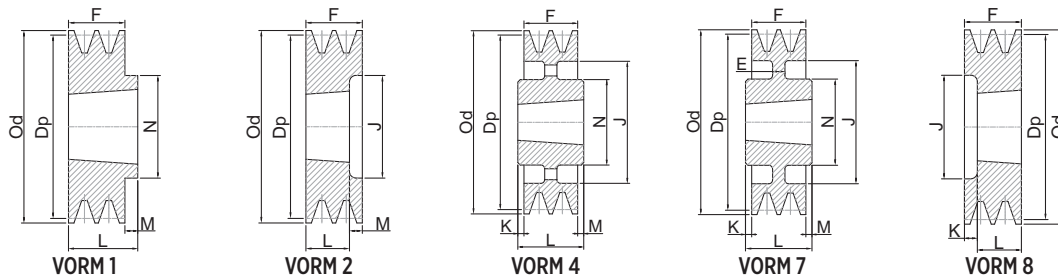

Referentie <i>Reference</i>	Groef- profiel <i>Groove</i>	Dp.	Bu-d Od.	Vorm <i>Form</i>	Groote klembus <i>Bush Size</i>	Max. boring <i>Max Bore</i>	E	F	J	K	L	M	N	Code
SPA63X1TL1108-4MP	SPA	63	68,5	8	1108	28	-	40	36	18	22	-	-	66 597 857
SPA67X1TL1108-4MP	SPA	67	72,5	1	1108	28	-	20	-	-	22	2	62	66 597 865
SPA71X1TL1108-4MP	SPA	71	76,5	1	1108	28	-	20	-	-	22	2	62	66 597 873
SPA75X1TL1108-4MP	SPA	75	80,5	1	1108	28	-	20	-	-	22	2	62	66 597 881
SPA80X1TL1210-4MP	SPA	80	85,5	1	1210	32	-	20	-	-	25	5	75	66 597 903
SPA85X1TL1210-4MP	SPA	85	90,5	1	1210	32	-	20	-	-	25	5	75	66 597 911
SPA90X1TL1210-4MP	SPA	90	95,5	1	1210	32	-	20	-	-	25	5	75	66 597 938
SPA95X1TL1210-4MP	SPA	95	100,5	1	1210	32	-	20	-	-	25	5	75	66 597 946
SPA100X1TL1610-4MP	SPA	100	105,5	1	1610	42	-	20	-	-	25	5	80	66 597 954
SPA106X1TL1610-4MP	SPA	106	111,5	1	1610	42	-	20	-	-	25	5	80	66 597 962
SPA112X1TL1610-4MP	SPA	112	117,5	1	1610	42	-	20	-	-	25	5	80	66 597 970
SPA118X1TL1610-4MP	SPA	118	123,5	1	1610	42	-	20	-	-	25	5	80	66 597 989
SPA125X1TL1610-4MP	SPA	125	130,5	1	1610	42	-	20	-	-	25	5	80	66 597 997
SPA132X1TL1610-4MP	SPA	132	137,5	2	1610	42	-	20	-	-	25	5	80	66 598 004
SPA140X1TL1610-4MP	SPA	140	145,5	1	1610	42	-	20	-	-	25	5	80	66 598 012
SPA150X1TL1610-4MP	SPA	150	155,5	1	1610	42	-	20	-	-	25	5	80	66 598 020
SPA160X1TL1610-4MP	SPA	160	165,5	1	1610	42	-	20	-	-	25	5	80	66 598 039
SPA170X1TL1610-4MP	SPA	170	175,5	1	1610	42	-	20	-	-	25	5	80	66 598 047
SPA180X1TL1610-4MP	SPA	180	185,5	7	1610	42	8	20	150	-	25	5	80	66 598 055
SPA190X1TL1610-4MP	SPA	190	195,5	7	1610	42	8	20	160	-	25	5	80	66 598 063
SPA200X1TL2012-4MP	SPA	200	205,5	7	2012	50	10	20	165	-	32	12	100	66 598 071
SPA224X1TL2012-4MP	SPA	224	229,5	4	2012	50	-	20	189	-	32	12	100	66 598 101
SPA250X1TL2012-4MP	SPA	250	255,5	4	2012	50	-	20	215	6	32	6	100	66 598 136
SPA280X1TL2012-4MP	SPA	280	285,5	4	2012	50	-	20	245	-	32	12	100	66 598 152
SPA315X1TL2012-4MP	SPA	315	320,5	4	2012	50	-	20	280	-	32	12	100	66 598 179
SPA355X1TL2012-4MP	SPA	355	360,5	4	2012	50	-	20	320	-	32	12	100	66 598 195
SPB100X1TL1610-4MP	SPB	100	107	1	1610	42	-	25	-	-	25	-	-	66 600 211
SPB112X1TL1610-4MP	SPB	112	119	1	1610	42	-	25	-	-	25	-	-	66 600 246
SPB118X1TL1610-4MP	SPB	118	125	1	1610	42	-	25	-	-	25	-	-	66 600 254
SPB125X1TL1610-4MP	SPB	125	132	1	1610	42	-	25	-	-	25	-	-	66 600 262
SPB132X1TL1610-4MP	SPB	132	139	1	1610	42	-	25	-	-	25	-	-	66 600 270
SPB140X1TL1610-4MP	SPB	140	147	1	1610	42	-	25	-	-	25	-	-	66 600 289
SPB150X1TL1610-4MP	SPB	150	157	7	1610	42	10	25	113	-	25	-	80	66 600 297
SPB160X1TL1610-4MP	SPB	160	167	7	1610	42	10	25	123	-	25	-	80	66 600 300

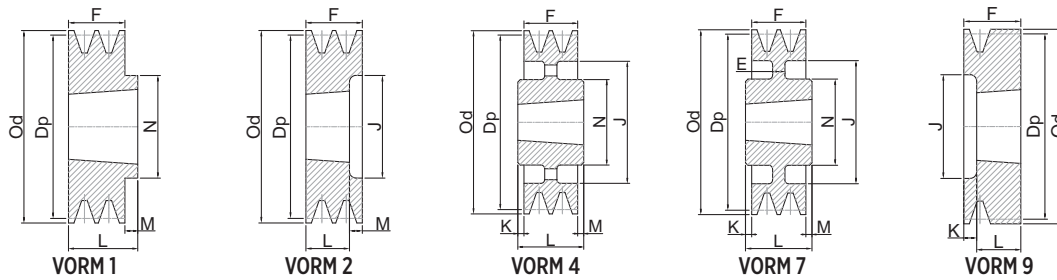
Taper-Lock V-riemschijven met 1 groef
1 groove taper lock V-pulleys

Referentie <i>Reference</i>	Groef- profiel <i>Groove</i>	Dp.	Bu-d Od.	Vorm <i>Form</i>	Groote klembus <i>Bush Size</i>	Max. boring <i>Max Bore</i>	E	F	J	K	L	M	N	Code
SPB170X1TL1610-4MP	SPB	170	177	7	1610	42	10	25	133	-	25	-	80	66 600 319
SPB180X1TL1610-4MP	SPB	180	187	7	1610	42	10	25	143	-	25	-	80	66 600 327
SPB200X1TL2012-4MP	SPB	200	207	7	2012	50	10	25	157	3,5	32	3,5	100	66 600 343
SPB280X1TL2012-4MP	SPB	280	287	4	2012	50	-	25	237	3,5	32	3,5	100	66 600 416
SPZ60X1TL1008-4MP	SPZ	60	64	9	1008	25	-	22	-	-	22	-	-	66 595 536
SPZ63X1TL1108-4MP	SPZ	63	67	1	1108	28	-	16	-	-	22	6	62	66 595 544
SPZ67X1TL1108-4MP	SPZ	67	71	1	1108	28	-	16	-	-	22	6	62	66 595 552
SPZ71X1TL1108-4MP	SPZ	71	75	1	1108	28	-	16	-	-	22	6	62	66 595 560
SPZ75X1TL1108-4MP	SPZ	75	79	1	1108	28	-	16	-	-	22	6	62	66 595 579
SPZ80X1TL1210-4MP	SPZ	80	84	1	1210	32	-	16	-	-	25	9	75	66 595 587
SPZ85X1TL1210-4MP	SPZ	85	89	1	1210	32	-	16	-	-	25	9	75	66 595 595
SPZ90X1TL1210-4MP	SPZ	90	94	1	1210	32	-	16	-	-	25	9	75	66 595 609
SPZ95X1TL1210-4MP	SPZ	95	99	1	1210	32	-	16	-	-	25	9	75	66 595 617
SPZ100X1TL1210-4MP	SPZ	100	104	1	1210	32	-	16	-	-	25	9	75	66 595 625
SPZ106X1TL1610-4MP	SPZ	106	110	1	1610	42	-	16	-	-	25	9	80	66 595 633
SPZ112X1TL1610-4MP	SPZ	112	116	1	1610	42	-	16	-	-	25	9	80	66 595 641
SPZ118X1TL1610-4MP	SPZ	118	122	1	1610	42	-	16	-	-	25	9	80	66 595 668
SPZ125X1TL1610-4MP	SPZ	125	129	1	1610	42	-	16	-	-	25	9	80	66 595 676
SPZ132X1TL1610-4MP	SPZ	132	136	2	1610	42	-	16	-	-	25	9	80	66 595 684
SPZ140X1TL1610-4MP	SPZ	140	144	1	1610	42	-	16	-	-	25	9	80	66 595 692
SPZ150X1TL1610-4MP	SPZ	150	154	1	1610	42	-	16	-	-	25	9	80	66 595 706
SPZ160X1TL1610-4MP	SPZ	160	164	1	1610	42	-	16	-	-	25	9	80	66 595 714
SPZ180X1TL1610-4MP	SPZ	180	184	7	1610	42	8	16	152	-	25	9	80	66 595 730
SPZ200X1TL2012-4MP	SPZ	200	204	7	2012	50	8	16	172	-	32	16	100	66 595 757
SPZ224X1TL2012-4MP	SPZ	224	228	4	2012	50	-	16	196	-	32	16	100	66 595 773
SPZ250X1TL2012-4MP	SPZ	250	254	4	2012	50	-	16	222	8	32	8	100	66 595 803

Taper-Lock V-riemschijven met 2 groeven

2 grooves taper lock V-pulleys

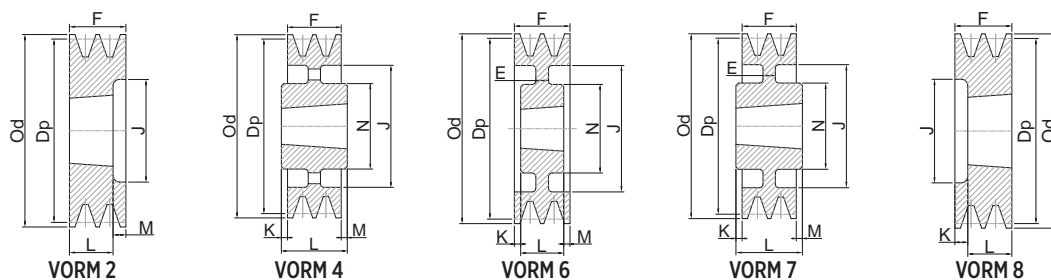

Referentie <i>Reference</i>	Groef- profiel <i>Groove</i>	Dp.	Bu-d Od.	Vorm <i>Form</i>	Grootte klembus <i>Bush Size</i>	Max. boring <i>Max Bore</i>	E	F	J	K	L	M	N	Code
SPA63X2TL1108-4MP	SPA	63	68,5	8	1108	28	-	55	36	33	22	-	-	66 598 268
SPA67X2TL1108-4MP	SPA	67	72,5	8	1108	28	-	35	37	13	22	-	-	66 598 276
SPA71X2TL1108-4MP	SPA	71	76,5	8	1108	28	-	35	40	13	22	-	-	66 598 284
SPA75X2TL1108-4MP	SPA	75	80,5	8	1108	28	-	35	44	13	22	-	-	66 598 292
SPA80X2TL1210-4MP	SPA	80	85,5	8	1210	32	-	35	50	10	25	-	-	66 598 306
SPA85X2TL1210-4MP	SPA	85	90,5	8	1210	32	-	35	55	10	25	-	-	66 598 314
SPA90X2TL1610-4MP	SPA	90	95,5	8	1610	42	-	35	59	10	25	-	-	66 598 322
SPA95X2TL1610-4MP	SPA	95	100,5	8	1610	42	-	35	63	10	25	-	-	66 598 330
SPA100X2TL1610-4MP	SPA	100	105,5	8	1610	42	-	35	66	10	25	-	-	66 598 349
SPA106X2TL1610-4MP	SPA	106	111,5	8	1610	42	-	35	72	10	25	-	-	66 598 357
SPA112X2TL1610-4MP	SPA	112	117,5	8	1610	42	-	35	78	10	25	-	-	66 598 365
SPA118X2TL1610-4MP	SPA	118	123,5	8	1610	42	-	35	84	10	25	-	-	66 598 373
SPA125X2TL1610-4MP	SPA	125	130,5	8	1610	42	-	35	91	10	25	-	-	66 598 381
SPA132X2TL2012-4MP	SPA	132	137,5	8	2012	50	-	35	98	3	32	-	-	66 598 403
SPA140X2TL2012-4MP	SPA	140	145,5	8	2012	50	-	35	106	3	32	-	-	66 598 411
SPA150X2TL2012-4MP	SPA	150	155,5	8	2012	50	-	35	116	3	32	-	-	66 598 438
SPA160X2TL2012-4MP	SPA	160	165,5	8	2012	50	35	125	3	32	-	-	66	66 598 446
SPA170X2TL2012-4MP	SPA	170	175,5	8	2012	50	35	135	3	32	-	-	66	66 598 454
SPA180X2TL2012-4MP	SPA	180	185,5	6	2012	50	10	35	146	1,5	32	1,5	100	66 598 462
SPA190X2TL2012-4MP	SPA	190	195,5	6	2012	50	10	35	156	1,5	32	1,5	100	66 598 470
SPA200X2TL2517-4MP	SPA	200	205,5	7	2517	60	10	35	165	5	45	5	120	66 598 489
SPA212X2TL2517-4MP	SPA	212	217,5	7	2517	60	10	35	178	5	45	5	120	66 598 497
SPA224X2TL2517-4MP	SPA	224	229,5	7	2517	60	10	35	189	5	45	5	120	66 598 500
SPA236X2TL2517-4MP	SPA	236	241,5	7	2517	60	-	35	202	5	45	5	120	66 598 519
SPA250X2TL2517-4MP	SPA	250	255,5	4	2517	60	-	35	215	5	45	5	120	66 598 527
SPA280X2TL2517-4MP	SPA	280	285,5	4	2517	60	-	35	245	-	45	10	120	66 598 543
SPA315X2TL2517-4MP	SPA	315	320,5	4	2517	60	-	35	280	-	45	10	120	66 598 578
SPA355X2TL2517-4MP	SPA	355	360,5	4	2517	60	-	35	320	-	45	10	120	66 598 594
SPA400X2TL2517-4MP	SPA	400	405,5	4	2517	60	-	35	365	-	45	10	120	66 598 616
SPB100X2TL1610-4MP	SPB	100	107	8	1610	42	-	44	62	19	25	-	-	66 600 513
SPB112X2TL1610-4MP	SPB	112	119	2	1610	42	-	44	72	-	25	19	-	66 600 548
SPB118X2TL1610-4MP	SPB	118	125	2	1610	42	-	44	78	-	25	19	-	66 600 556
SPB125X2TL2012-4MP	SPB	125	132	2	2012	50	-	44	82	-	32	12	-	66 600 564
SPB132X2TL2012-4MP	SPB	132	139	2	2012	50	-	44	89	-	32	12	-	66 600 572
SPB140X2TL2012-4MP	SPB	140	147	2	2012	50	-	44	97	-	32	12	-	66 600 580
SPB150X2TL2012-4MP	SPB	150	157	2	2012	50	-	44	107	-	32	12	-	66 600 599
SPB160X2TL2012-4MP	SPB	160	167	2	2012	50	-	44	117	-	32	12	-	66 600 602
SPB170X2TL2012-4MP	SPB	170	177	2	2012	50	-	44	127	-	32	12	-	66 600 610

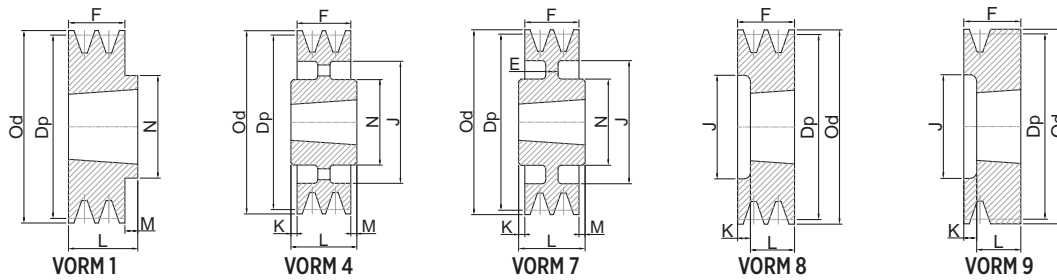
Taper-Lock V-riemschijven met 2 groeven
2 grooves taper lock V-pulleys

Referentie <i>Reference</i>	Groef- profiel <i>Groove</i>	Dp.	Bu-d Od.	Vorm <i>Form</i>	Groote klembus <i>Bush Size</i>	Max. boring <i>Max Bore</i>	E	F	J	K	L	M	N	Code
SPB180X2TL2517-4MP	SPB	180	187	1	2517	60	-	44	-	-	45	1	120	66 600 629
SPB190X2TL2517-4MP	SPB	190	197	1	2517	60	-	44	-	-	45	1	120	66 600 637
SPB200X2TL2517-4MP	SPB	200	207	1	2517	60	-	44	-	-	45	1	120	66 600 645
SPB212X2TL2517-4MP	SPB	212	219	7	2517	60	10	44	169	-	45	1	120	66 600 653
SPB224X2TL2517-4MP	SPB	224	231	7	2517	60	10	44	181	1	45	-	120	66 600 661
SPB236X2TL2517-4MP	SPB	236	243	7	2517	60	10	44	193	1	45	-	120	66 600 688
SPB250X2TL2517-4MP	SPB	250	257	4	2517	60	-	44	207	1	45	-	120	66 600 696
SPB280X2TL2517-4MP	SPB	280	287	4	2517	60	-	44	237	1	45	-	120	66 600 726
SPB300X2TL2517-4MP	SPB	300	307	4	2517	60	-	44	257	1	45	-	120	66 600 734
SPB315X2TL2517-4MP	SPB	315	322	4	2517	60	-	44	272	1	45	-	120	66 600 742
SPB355X2TL3020-4MP	SPB	355	362	4	3020	75	-	44	312	3,5	51	3,5	150	66 600 769
SPZ60X2TL1108-4MP	SPZ	60	64	9	1108	28	-	49	36	25	24	-	-	66 595 919
SPZ63X2TL1108-4MP	SPZ	63	67	8	1108	28	-	28	40	6	22	-	-	66 595 927
SPZ67X2TL1108-4MP	SPZ	67	71	8	1108	28	-	28	42	6	22	-	-	66 595 935
SPZ71X2TL1108-4MP	SPZ	71	75	8	1108	28	-	28	42	6	22	-	-	66 595 943
SPZ75X2TL1210-4MP	SPZ	75	79	8	1210	32	-	28	51	3	25	-	-	66 595 951
SPZ80X2TL1210-4MP	SPZ	80	84	8	1210	32	-	28	51	3	25	-	-	66 595 978
SPZ85X2TL1610-4MP	SPZ	85	89	8	1610	42	-	28	60	3	25	-	-	66 595 986
SPZ90X2TL1610-4MP	SPZ	90	94	8	1610	42	-	28	61	3	25	-	-	66 595 994
SPZ95X2TL1610-4MP	SPZ	95	99	8	1610	42	-	28	66	3	25	-	-	66 596 001
SPZ100X2TL1610-4MP	SPZ	100	104	8	1610	42	-	28	71	3	25	-	-	66 596 028
SPZ106X2TL1610-4MP	SPZ	106	110	8	1610	42	-	28	76	3	25	-	-	66 596 036
SPZ112X2TL1610-4MP	SPZ	112	116	8	1610	42	-	28	84	3	25	-	-	66 596 044
SPZ118X2TL1610-4MP	SPZ	118	122	8	1610	42	-	28	90	3	25	-	-	66 596 052
SPZ125X2TL1610-4MP	SPZ	125	129	8	1610	42	-	28	97	3	25	-	-	66 596 060
SPZ132X2TL1610-4MP	SPZ	132	136	8	1610	42	-	28	104	3	25	-	-	66 596 079
SPZ140X2TL1610-4MP	SPZ	140	144	8	1610	42	-	28	115	3	25	-	-	66 596 087
SPZ150X2TL2012-4MP	SPZ	150	154	1	2012	50	-	28	-	-	32	4	100	66 596 095
SPZ160X2TL2012-4MP	SPZ	160	164	1	2012	50	-	28	-	-	32	4	100	66 596 109
SPZ180X2TL2012-4MP	SPZ	180	184	7	2012	50	8	28	152	-	32	4	100	66 596 125
SPZ200X2TL2012-4MP	SPZ	200	204	7	2012	50	8	28	171	-	32	4	100	66 596 141
SPZ224X2TL2012-4MP	SPZ	224	228	4	2012	50	-	28	196	-	32	4	100	66 596 176
SPZ250X2TL2012-4MP	SPZ	250	254	4	2012	50	-	28	222	2	32	2	100	66 596 192

Taper-Lock V-riemschijven met 3 groeven

3 grooves taper lock V-pulleys

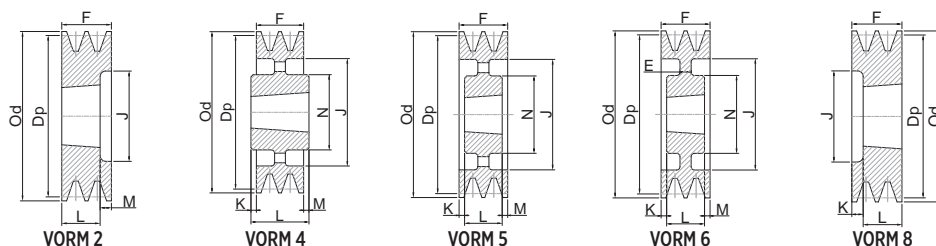

Referentie <i>Reference</i>	Groef-profiel <i>Groove</i>	Dp.	Bu-d Od.	Vorm <i>Form</i>	Grootte klembus <i>Bush Size</i>	Max. boring <i>Max Bore</i>	E	F	J	K	L	M	N	Code
SPA71X3TL1108-4MP	SPA	71	76,5	8	1108	28	-	50	40	28	22	-	-	66 598 667
SPA80X3TL1210-4MP	SPA	80	85,5	8	1210	32	-	50	47	25	25	-	-	66 598 683
SPA85X3TL1210-4MP	SPA	85	90,5	8	1210	32	-	50	50	25	25	-	-	66 598 691
SPA90X3TL1610-4MP	SPA	90	95,5	8	1610	42	-	50	60	25	25	-	-	66 598 705
SPA95X3TL1610-4MP	SPA	95	100,5	8	1610	42	-	50	64	25	25	-	-	66 598 713
SPA100X3TL1610-4MP	SPA	100	105,5	2	1610	42	-	50	70	-	25	25	-	66 598 721
SPA106X3TL1610-4MP	SPA	106	111,5	2	1610	42	-	50	76	-	25	25	-	66 598 748
SPA112X3TL2012-4MP	SPA	112	117,5	8	2012	50	-	50	83	18	32	-	-	66 598 756
SPA118X3TL2012-4MP	SPA	118	123,5	2	2012	50	-	50	86	-	32	18	-	66 598 764
SPA125X3TL2012-4MP	SPA	125	130,5	2	2012	50	-	50	92	-	32	18	-	66 598 772
SPA132X3TL2012-4MP	SPA	132	137,5	2	2012	50	-	50	98	-	32	18	-	66 598 780
SPA140X3TL2517-4MP	SPA	140	145,5	8	2517	60	-	50	106	5	45	-	-	66 598 799
SPA150X3TL2517-4MP	SPA	150	155,5	8	2517	60	-	50	116	5	45	-	-	66 598 802
SPA160X3TL2517-4MP	SPA	160	165,5	8	2517	60	-	50	126	5	45	-	-	66 598 810
SPA170X3TL2517-4MP	SPA	170	175,5	8	2517	60	-	50	138	5	45	-	-	66 598 829
SPA180X3TL2517-4MP	SPA	180	185,5	8	2517	60	-	50	146	5	45	-	-	66 598 837
SPA190X3TL2517-4MP	SPA	190	195,5	8	2517	60	-	50	158	5	45	-	-	66 598 845
SPA200X3TL2517-4MP	SPA	200	205,5	6	2517	60	12	50	165	2,5	45	2,5	120	66 598 853
SPA212X3TL2517-4MP	SPA	212	217,5	6	2517	60	12	50	178	2,5	45	2,5	120	66 598 861
SPA224X3TL2517-4MP	SPA	224	229,5	5	2517	60	-	50	189	2,5	45	2,5	120	66 598 888
SPA250X3TL2517-4MP	SPA	250	255,5	5	2517	60	-	50	215	2,5	45	2,5	120	66 598 918
SPA280X3TL2517-4MP	SPA	280	285,5	5	2517	60	-	50	245	2,5	45	2,5	120	66 598 934
SPA315X3TL3020-4MP	SPA	315	320,5	4	3020	75	-	50	280	0,5	51	0,5	150	66 598 950
SPA355X3TL3020-4MP	SPA	355	360,5	4	3020	75	-	50	320	0,5	51	0,5	150	66 598 977
SPA400X3TL3020-4MP	SPA	400	405,5	4	3020	75	-	50	365	0,5	51	0,5	150	66 598 993
SPB100X3TL1610-4MP	SPB	100	107	8	1610	42	-	63	57	38	25	-	-	66 600 882
SPB106X3TL1610-4MP	SPB	106	113	8	1610	42	-	63	67	38	25	-	-	66 600 890
SPB112X3TL1610-4MP	SPB	112	119	2	1610	42	-	63	72	-	25	38	-	66 600 904
SPB118X3TL1610-4MP	SPB	118	125	2	1610	42	-	63	78	-	25	38	-	66 600 912
SPB125X3TL2012-4MP	SPB	125	132	2	2012	50	-	63	82	-	32	31	-	66 600 920
SPB132X3TL2012-4MP	SPB	132	139	2	2012	50	-	63	89	-	32	31	-	66 600 939
SPB140X3TL2012-4MP	SPB	140	147	2	2012	50	-	63	97	-	32	31	-	66 600 947
SPB150X3TL2517-4MP	SPB	150	157	2	2517	60	-	63	107	-	45	18	-	66 600 955
SPB160X3TL2517-4MP	SPB	160	167	2	2517	60	-	63	117	-	45	18	-	66 600 963
SPB170X3TL2517-4MP	SPB	170	177	2	2517	60	-	63	127	-	45	18	-	66 600 971
SPB180X3TL2517-4MP	SPB	180	187	2	2517	60	-	63	137	-	45	18	-	66 600 998

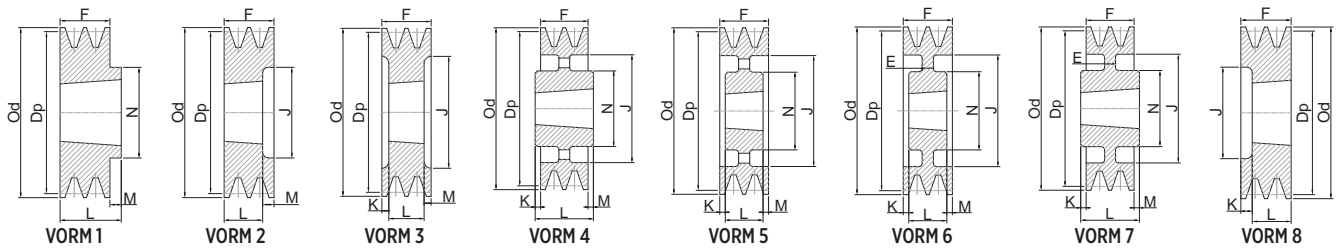
Taper-Lock V-riemschijven met 3 groeven
3 grooves taper lock V-pulleys

Referentie Reference	Groef- profiel Groove	Dp.	Bu-d Od.	Vorm Form	Groote klembus Bush Size	Max. boring Max Bore	E	F	J	K	L	M	N	Code
SPB190X3TL2517-4MP	SPB	190	197	2	2517	60	-	63	147	-	45	18	-	66 601 005
SPB200X3TL2517-4MP	SPB	200	207	2	2517	60	-	63	157	-	45	18	-	66 601 013
SPB212X3TL2517-4MP	SPB	212	219	6	2517	60	20	63	169	-	45	18	120	66 601 021
SPB224X3TL2517-4MP	SPB	224	231	6	2517	60	20	63	181	-	45	18	120	66 601 048
SPB236X3TL2517-4MP	SPB	236	243	6	2517	60	16	63	193	-	45	18	120	66 601 056
SPB250X3TL3020-4MP	SPB	250	257	6	3020	75	16	63	207	-	51	12	150	66 601 064
SPB280X3TL3020-4MP	SPB	280	287	5	3020	75	-	63	237	6	51	6	150	66 601 080
SPB300X3TL3020-4MP	SPB	300	307	5	3020	75	-	63	257	6	51	6	150	66 601 099
SPB315X3TL3020-4MP	SPB	315	322	5	3020	75	-	63	272	6	51	6	150	66 601 102
SPB355X3TL3020-4MP	SPB	355	362	5	3020	75	-	63	312	6	51	6	150	66 601 129
SPB400X3TL3535-4MP	SPB	400	407	4	3535	90	-	63	357	13	89	13	170	66 601 145
SPB450X3TL3535-4MP	SPB	450	457	4	3535	90	-	63	407	-	89	26	170	66 601 161
SPB500X3TL3535-4MP	SPB	500	507	4	3535	90	-	63	457	-	89	26	170	66 601 196
SPC200X3TL2517-4MP	SPC	200	209,6	3	2517	60	-	85	148	20	45	20	-	66 603 385
SPC236X3TL3020-4MP	SPC	236	245,6	3	3020	75	-	85	185	17	51	17	-	66 603 415
SPC250X3TL3020-4MP	SPC	250	259,6	3	3020	75	-	85	198	17	51	17	-	66 603 423
SPC265X3TL3535-4MP	SPC	265	274,6	1	3535	90	-	85	215	-	89	4	170	66 603 431
SPC280X3TL3535-4MP	SPC	280	289,6	7	3535	90	-	85	228	-	89	4	170	66 603 458
SPC315X3TL3535-4MP	SPC	315	324,6	7	3535	90	18	85	262	2	89	2	170	66 603 474
SPZ63X3TL1108-4MP	SPZ	63	67	8	1108	28	-	40	40	18	22	-	-	66 596 273
SPZ80X3TL1210-4MP	SPZ	80	84	8	1210	32	-	40	51	15	25	-	-	66 596 338
SPZ85X3TL1610-4MP	SPZ	85	89	8	1610	42	-	40	60	15	25	-	-	66 596 346
SPZ90X3TL1610-4MP	SPZ	90	94	8	1610	42	-	40	61	15	25	-	-	66 596 354
SPZ95X3TL1610-4MP	SPZ	95	99	8	1610	42	-	40	66	15	25	-	-	66 596 362
SPZ100X3TL1610-4MP	SPZ	100	104	8	1610	42	-	40	71	15	25	-	-	66 596 370
SPZ112X3TL2012-4MP	SPZ	112	116	8	2012	50	-	40	84	8	32	-	-	66 596 397
SPZ118X3TL2012-4MP	SPZ	118	122	8	2012	50	-	40	92	8	32	-	-	66 596 400
SPZ125X3TL2012-4MP	SPZ	125	129	2	2012	50	-	40	97	-	32	8	-	66 596 419
SPZ140X3TL2012-4MP	SPZ	140	144	2	2012	50	-	40	112	-	32	8	-	66 596 435
SPZ150X3TL2012-4MP	SPZ	150	154	2	2012	50	-	40	122	-	32	8	-	66 596 443
SPZ160X3TL2012-4MP	SPZ	160	164	2	2012	50	-	40	132	-	32	8	-	66 596 451
SPZ180X3TL2012-4MP	SPZ	180	184	6	2012	50	-	40	152	-	32	8	-	66 596 486
SPZ224X3TL2012-4MP	SPZ	224	228	5	2012	50	-	40	196	4	32	4	100	66 596 524
SPZ250X3TL2012-4MP	SPZ	250	254	5	2012	50	-	40	222	4	32	4	100	66596540

Taper-Lock V-riemschijven met 4 groeven

4 grooves taper lock V-pulleys

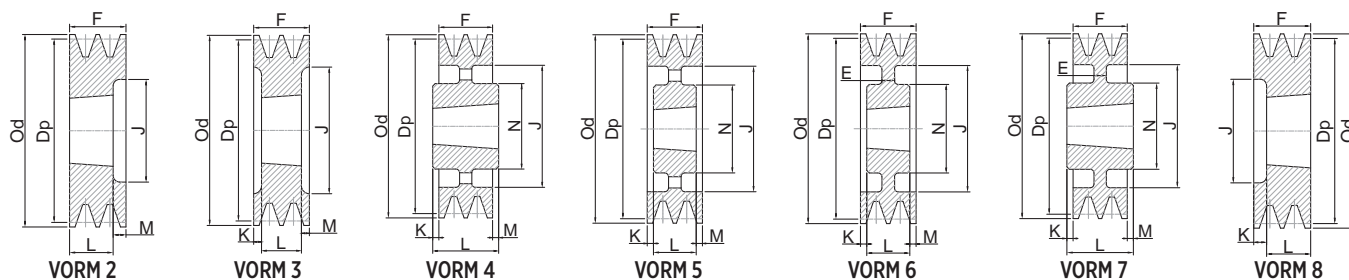

Referentie <i>Reference</i>	Groef- profiel <i>Groove</i>	Dp.	Bu-d Od.	Vorm <i>Form</i>	Grootte klembus <i>Bush Size</i>	Max. boring <i>Max Bore</i>	E	F	J	K	L	M	N	Code
SPA90X4TL1615-4MP	SPA	90	95,5	3	1615	42	-	65	64	13,5	38	13,5	-	66 599 094
SPA100X4TL1615-4MP	SPA	100	105,5	2	1615	42	-	65	70	-	38	27	-	66 599 116
SPA112X4TL2012-4MP	SPA	112	117,5	8	2012	50	-	65	80	33	32	-	-	66 599 132
SPA125X4TL2012-4MP	SPA	125	130,5	2	2012	50	-	65	92	-	32	33	-	66 599 159
SPA132X4TL2517-4MP	SPA	132	137,5	2	2517	60	-	65	98	-	45	20	-	66 599 167
SPA140X4TL2517-4MP	SPA	140	145,5	2	2517	60	-	65	106	-	45	20	-	66 599 175
SPA150X4TL2517-4MP	SPA	150	155,5	2	2517	60	-	65	116	-	45	20	-	66 599 183
SPA160X4TL2517-4MP	SPA	160	165,5	2	2517	60	-	65	126	-	45	20	-	66 599 191
SPA180X4TL2517-4MP	SPA	180	185,5	2	2517	60	-	65	146	-	45	20	-	66 599 213
SPA190X4TL2517-4MP	SPA	190	195,5	2	2517	60	-	65	158	-	45	20	-	66 599 221
SPA200X4TL3020-4MP	SPA	200	205,5	2	3020	75	-	65	165	-	51	14	-	66 599 248
SPA224X4TL3020-4MP	SPA	224	229,5	2	3020	75	-	65	189	-	51	14	-	66 599 264
SPA250X4TL3020-4MP	SPA	250	255,5	6	3020	75	15	65	215	7	51	7	150	66 599 280
SPA280X4TL3020-4MP	SPA	280	285,5	5	3020	75	-	65	245	7	51	7	150	66 599 302
SPA315X4TL3020-4MP	SPA	315	320,5	5	3020	75	-	65	280	7	51	7	150	66 599 329
SPA355X4TL3020-4MP	SPA	355	360,5	5	3020	75	-	65	320	7	51	7	150	66 599 345
SPB125X4TL2012-4MP	SPB	125	132	3	2012	50	-	82	82	25	32	25	-	66 601 331
SPB132X4TL2012-4MP	SPB	132	139	3	2012	50	-	82	89	25	32	25	-	66 601 358
SPB140X4TL2517-4MP	SPB	140	147	3	2517	60	-	82	97	18,5	45	18,5	-	66 601 366
SPB150X4TL2517-4MP	SPB	150	157	3	2517	60	-	82	107	18,5	45	18,5	-	66 601 374
SPB160X4TL2517-4MP	SPB	160	167	3	2517	60	-	82	117	18,5	45	18,5	-	66 601 382
SPB170X4TL2517-4MP	SPB	170	177	3	2517	60	-	82	127	18,5	45	18,5	-	66 601 390
SPB180X4TL2517-4MP	SPB	180	187	3	2517	60	-	82	137	18,5	45	18,5	-	66 601 404
SPB190X4TL2517-4MP	SPB	190	197	3	2517	60	-	82	147	18,5	45	18,5	-	66 601 412
SPB200X4TL3020-4MP	SPB	200	207	3	3020	75	-	82	157	15,5	51	15,5	-	66 601 420
SPB212X4TL3020-4MP	SPB	212	219	3	3020	75	-	82	169	15,5	51	15,5	-	66 601 439
SPB224X4TL3020-4MP	SPB	224	231	3	3020	75	-	82	181	15,5	51	15,5	-	66 601 447
SPB236X4TL3020-4MP	SPB	236	243	3	3020	75	-	82	193	15,5	51	15,5	-	66 601 455
SPB250X4TL3020-4MP	SPB	250	257	6	3020	75	16	82	207	15,5	51	15,5	150	66 601 463
SPB280X4TL3020-4MP	SPB	280	287	6	3020	75	16	82	237	15,5	51	15,5	150	66 601 498
SPB300X4TL3020-4MP	SPB	300	307	5	3020	75	-	82	257	15,5	51	15,5	150	66 601 501
SPB315X4TL3535-4MP	SPB	315	322	7	3535	90	16	82	272	3,5	89	3,5	170	66 601 528
SPB355X4TL3535-4MP	SPB	355	362	4/7	3535	90	-	82	312	3,5	89	3,5	170	66 601 544
SPC212X4TL3020-4MP	SPC	212	221,6	3	3020	75	-	110,5	156	29,75	51	29,75	-	66 603 709
SPC250X4TL3535-4MP	SPC	250	259,6	3	3535	90	-	110,5	198	10,75	89	10,75	-	66 603 733
SPC280X4TL3535-4MP	SPC	280	289,6	3	3535	90	-	110,5	228	10,75	89	10,75	-	66 603 768

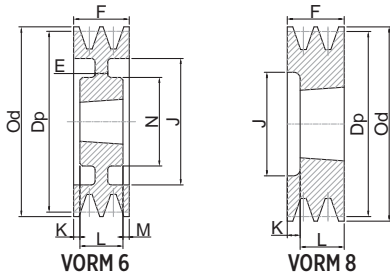
Taper-Lock V-riemschijven met 4 groeven
4 grooves taper lock V-pulleys

Referentie <i>Reference</i>	Groef- profiel <i>Groove</i>	Dp.	Bu-d Od.	Vorm <i>Form</i>	Grootte klembus <i>Bush Size</i>	Max. boring <i>Max Bore</i>	E	F	J	K	L	M	N	Code
SPC300X4TL3535-4MP	SPC	300	309,6	6	3535	90	20	110,5	247	10,75	89	10,75	170	66 603 776
SPC315X4TL3535-4MP	SPC	315	324,6	6	3535	90	20	110,5	262	10,75	89	10,75	170	66 603 784
SPZ112X4TL2012-4MP	SPZ	112	116	8	2012	50	-	52	86	20	32	-	-	66 596 729

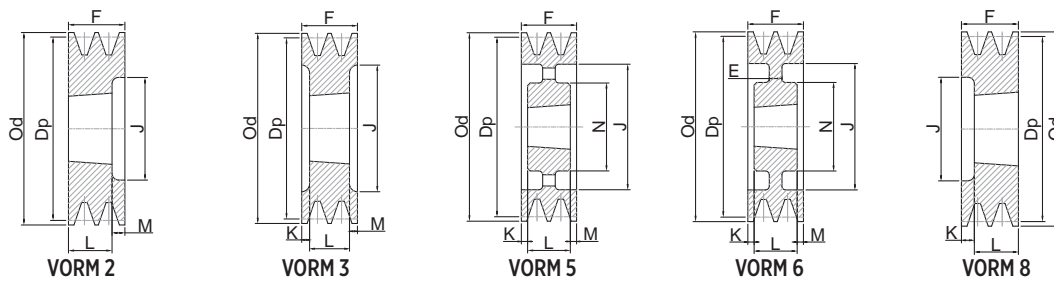
Taper-Lock V-riemschijven met 5 groeven
5 grooves taper lock V-pulleys

Referentie <i>Reference</i>	Groef- profiel <i>Groove</i>	Dp.	Bu-d Od.	Vorm <i>Form</i>	Grootte klembus <i>Bush Size</i>	Max. boring <i>Max Bore</i>	E	F	J	K	L	M	N	Code
SPA112X5TL2012-4MP	SPA	112	117,5	8	2012	50	-	80	80	48	32	-	-	66 599 507
SPA140X5TL2517-4MP	SPA	140	145,5	3	2517	60	-	80	106	17,5	45	17,5	-	66 599 558
SPA224X5TL3020-4MP	SPA	224	229,5	2	3020	75	-	80	189	-	51	29	-	66 599 639
SPB140X5TL2517-4MP	SPB	140	147	3	2517	60	-	101	101	28	45	28	-	66 601 722
SPB150X5TL2517-4MP	SPB	150	157	3	2517	60	-	101	107	28	45	28	-	66 601 730
SPB160X5TL2517-4MP	SPB	160	167	3	2517	60	-	101	117	28	45	28	-	66 601 749
SPB180X5TL3020-4MP	SPB	180	187	3	3020	75	-	101	137	25	51	25	-	66 601 765
SPB190X5TL3020-4MP	SPB	190	197	3	3020	75	-	101	147	25	51	25	-	66 601 773
SPB200X5TL3020-4MP	SPB	200	207	3	3020	75	-	101	157	25	51	25	-	66 601 781
SPB212X5TL3020-4MP	SPB	212	219	3	3020	75	-	101	169	25	51	25	-	66 601 803
SPB224X5TL3020-4MP	SPB	224	231	3	3020	75	-	101	181	25	51	25	-	66 601 811
SPB236X5TL3535-4MP	SPB	236	243	3	3535	90	-	101	193	6	89	6	-	66 601 838
SPB250X5TL3535-4MP	SPB	250	257	3	3535	90	-	101	207	6	89	6	-	66 601 846
SPB280X5TL3535-4MP	SPB	280	287	6	3535	90	18	101	237	6	89	6	170	66 601 862
SPB300X5TL3535-4MP	SPB	300	307	6	3535	90	18	101	257	6	89	6	170	66 601 870
SPB315X5TL3535-4MP	SPB	315	322	6	3535	90	18	101	272	6	89	6	170	66 601 889
SPB400X5TL3535-4MP	SPB	400	407	5	3535	90	-	101	357	6	89	6	170	66 601 927
SPB500X5TL3535-4MP	SPB	500	507	5	3535	90	-	101	457	-	89	12	170	66 601 978
SPC250X5TL3535-4MP	SPC	250	259,6	3	3535	90	-	136	198	23,5	89	23,5	-	66 604 020
SPC280X5TL3535-4MP	SPC	280	289,6	3	3535	90	-	136	228	23,5	89	23,5	-	66 604 047

Taper-Lock V-riemschijven met 6 groeven

6 grooves taper lock V-pulleys

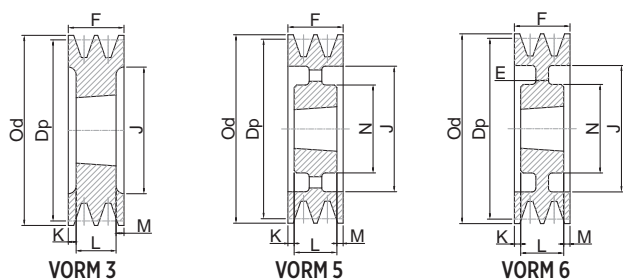

Referentie <i>Reference</i>	Groef- profiel <i>Groove</i>	Dp.	Bu-d Od.	Vorm <i>Form</i>	Grootte klembus <i>Bush Size</i>	Max. boring <i>Max Bore</i>	E	F	J	K	L	M	N	Code
SPB630X6TL4040-4MP	SPB	630	637	5	4040	100	-	120	587	-	102	18	200	66 602 362
SPB140X6TL2517-4MP	SPB	140	147	3	2517	60	-	120	102	37,5	45	37,5	-	66 602 087
SPB160X6TL3020-4MP	SPB	160	167	3	3020	75	-	120	123	34,5	51	34,5	-	66 602 109
SPB180X6TL3020-4MP	SPB	180	187	3	3020	75	-	120	137	34,5	51	34,5	-	66 602 125
SPB200X6TL3020-4MP	SPB	200	207	3	3020	75	-	120	157	34,5	51	34,5	-	66 602 141
SPB250X6TL3535-4MP	SPB	250	257	3	3535	90	-	120	207	15,5	89	15,5	-	66 602 192
SPB315X6TL3535-4MP	SPB	315	322	6	3535	90	18	120	272	15,5	89	15,5	170	66 602 230
SPC224X6TL3535-4MP	SPC	224	233,6	3	3535	90	-	161,5	173	36,25	89	36,25	-	66 604 276
SPC250X6TL3535-4MP	SPC	250	259,6	3	3535	90	-	161,5	198	36,25	89	36,25	-	66 604 292
SPC300X6TL3535-4MP	SPC	300	309,6	6	3535	90	20	161,5	247	36,25	89	36,25	170	66 604 322

Taper-Lock V-riemschijven met 8 groeven

8 grooves taper lock V-pulleys

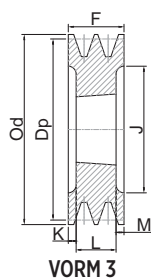

Referentie <i>Reference</i>	Groef- profiel <i>Groove</i>	Dp.	Bu-d Od.	Vorm <i>Form</i>	Grootte klembus <i>Bush Size</i>	Max. boring <i>Max Bore</i>	E	F	J	K	L	M	N	Code
SPC280X8TL3535-4MP	SPC	280	289,6	3	3535	90	-	212,5	228	61,75	89	61,75	-	66 604 586

HOE KIEST U

HOW TO CHOOSE

Een verstelbare riemschijf

An adjustable pulley

Een verstelbare riemschijf wordt gebruikt om de steekdiameter van een riemschijf te veranderen en daardoor de snelheidsratio tussen bijvoorbeeld een motor en machine (lastwerktuig).

An adjustable pulley is used for changing the pitch diameter of a pulley, and therefore the speed ratio between motor and receiver. The fine-tuning has to be done immobilised.

Om een verstelbare riemschijf te kiezen, controleert u het volgende:

To choose an adjustable pulley, you have to check :

- De steekdiameter
The pitch diameter
- Het aantal groeven: 1 of 2
The number of grooves : 1 or 2
- De doorsnede van de V-riem
The V-belt section

De riemschijf op de foto is bijvoorbeeld een **PV 139 A 2 -4MP**

For example, the pulley on the photo is

Verstelbare riemschijf
Adjustable Pulley

Steekdiameter 139 mm
Pitch diameter 139 mm

A-profiel
A profil

2 groeven
2 grooves



Al onze riemschijven zijn vervaardigd van gietijzer GG25 en gefosfateerd om ze te beschermen tegen corrosie.
Our trapezoidal pulleys are made of cast iron GG25, phosphated, in order to protect them from rust.

Verstelbare riemschijven met 1 groef

1 groove adjustable pulleys

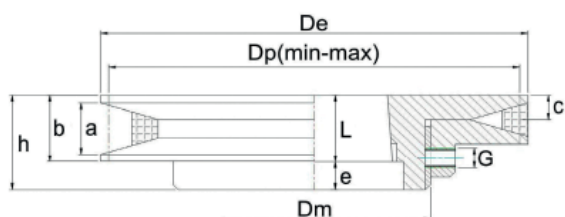

Referentie <i>Reference</i>	Groote klembus <i>Bush size</i>	Boring klembus <i>Bore of bush</i>	Profiel riem- schijf <i>Belt profile</i>	De	Dm	Dp min./ max.	a max./ min.	b max.	b min.	c	e	G	h	L	Code
PV084Z1-4MP	1108	10-28mm	Z	84	50	62 / 80	14,5 / 10	19,5	15	7,5	-	6	28	28	67 725 816
PV095Z1-4MP	1108	10-28mm	Z	95	60	73 / 91	14,5 / 10	20,5	16	8	8	6	30	22	67 725 840
PV108A1-4MP	1210	11-30mm	A	108	62	76 / 102	19,5 / 13	25,5	19	9,5	12	8	39	27	67 725 859
PV120A1-4MP	1210	11-30mm	A	120	72	88 / 114	19,5 / 13	26,5	20	10	10	8	36	26	67 725 867
PV139A1-4MP	1610	14-40mm	A	139	85	109 / 133	18,9 / 13	25,9	20	10	11	8	37	26	67 725 875
PV156A1-4MP	1610	14-40mm	A	156	85	126 / 150	18,9 / 13	25,9	20	10	11	8	37	26	67 725 891
PV164A1-4MP	1610	14-40mm	A	164	85	134 / 158	18,9 / 13	25,9	20	10	8	8	37	29	67 725 905

Verstelbare riemschijven met 2 groeven

2 grooves adjustable pulleys

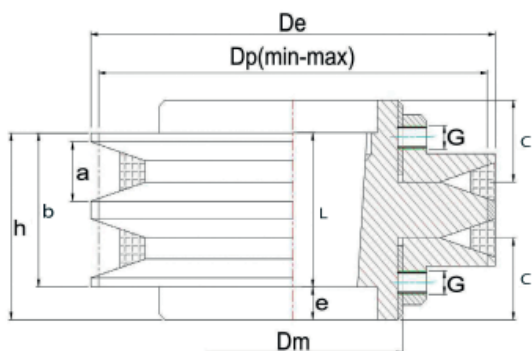

Referentie <i>Reference</i>	Groote klembus <i>Bush size</i>	Boring klembus <i>Bore of bush</i>	Profiel riem- schijf <i>Belt profile</i>	De	Dm	Dp min./ max.	a max./ min.	b max.	b min.	c	e	G	h	L	Code
PV139A2-4MP	1615	14-40mm	A	139	85	109 / 133	18,9 / 13	46,8	35	27	14,5	8	69	38,5	67 725 883